

Heat savings and district heating in TIMES-DTU model

Stefan Petrović, Energy Systems Analysis group, Technical
University of Denmark

Model built by:

- Energy Systems Analysis group, DTU
- IntERACT group, Danish Energy Agency
- E4SMA

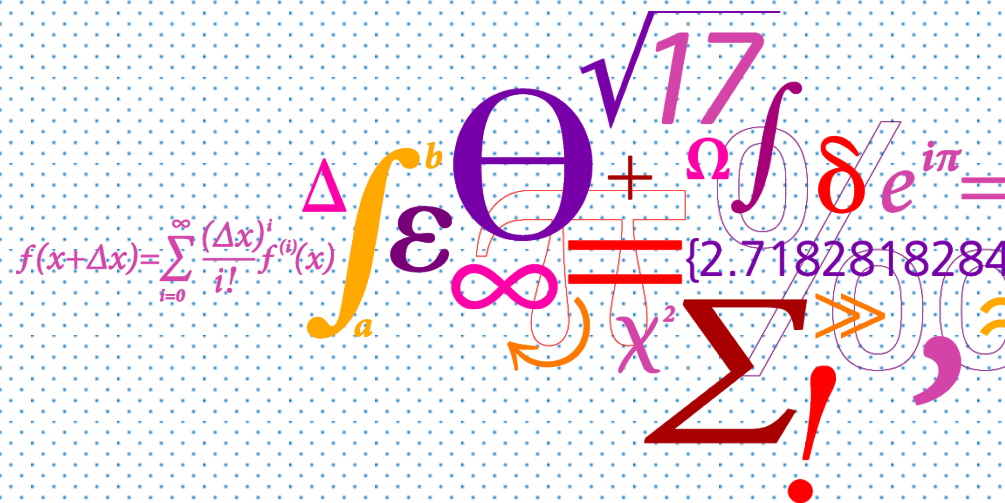

Heat savings and district heating in TIMES-DTU model

Presentation plan

- Heat savings and district heating in the past 40 years
- Modelling of heat savings in TIMES-DTU
- Modelling of district heating in TIMES-DTU
- Heat savings and district heating until 2050 – results from TIMES-DTU

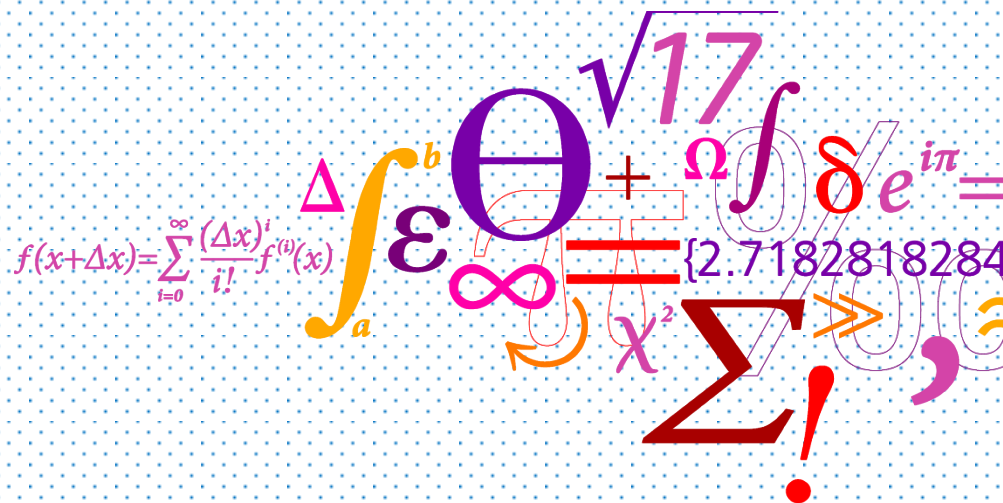

Heat savings and district heating in the past 40 years



- Denmark was totally dependent on the import of oil in 1973
- Oil has been replaced by the mix of natural gas, coal and renewables
- Primary energy supply remained the same
- Despite the growth in building mass by more than 50%, primary energy consumed for heating decreased by more than 30 %
- District heating share increased from 28 % to 54 %

Danish goals for the future

- 50 % of electricity production from wind starting from 2020
- No fossil fuels in production of electricity and heat from 2035
- No fossil fuels in society starting from 2050
- **What is the role of heat savings and district heating ?**

Supply of heat and DHW in TIMES-DTU

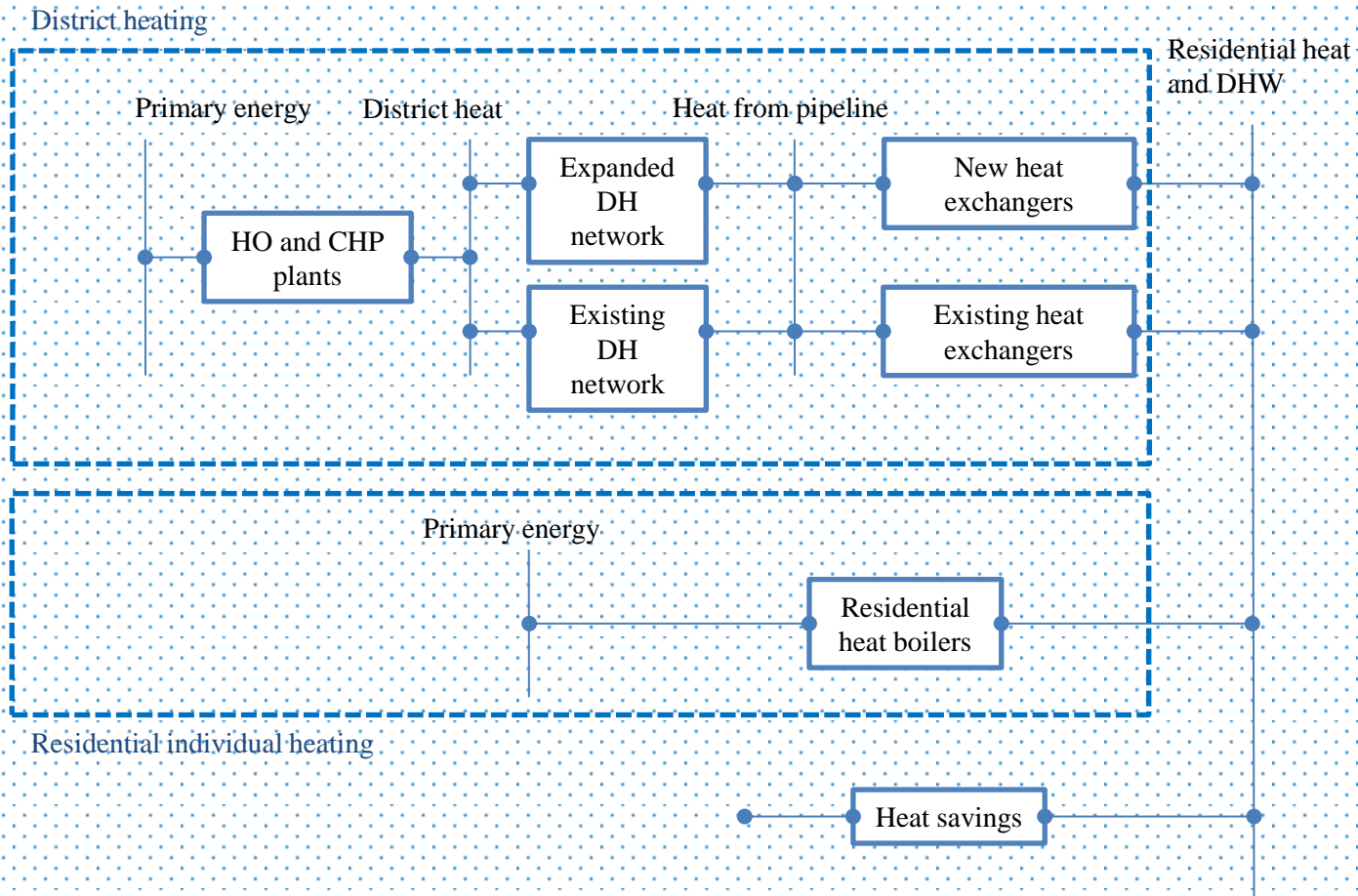

Heat savings in TIMES-DTU



Before TIMES-DTU

- Detailed calculations of potentials and costs were done for 360 building types
- Different levels for five different elements (walls, floors, ..) were considered

Heat savings in TIMES-DTU

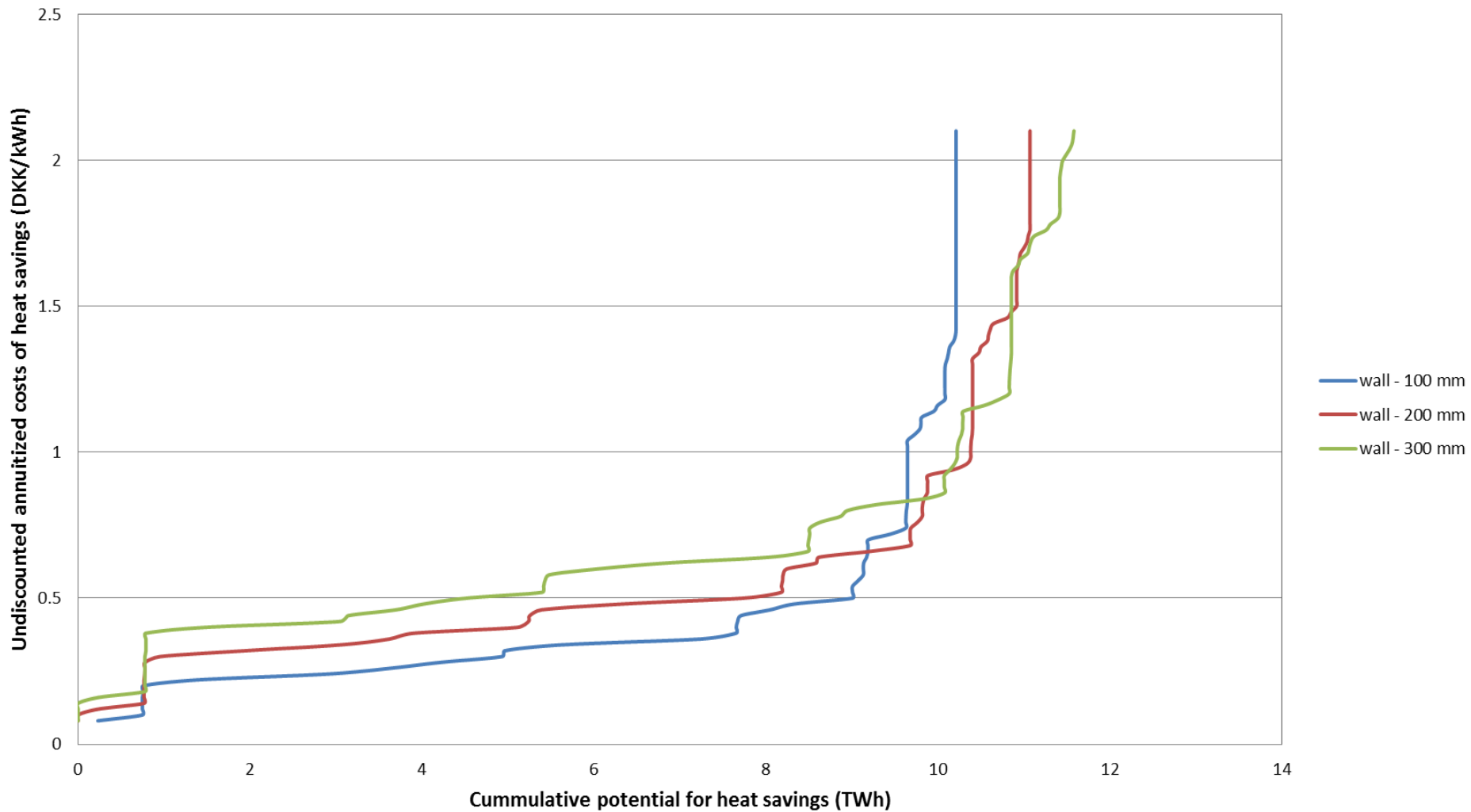

Heat savings in TIMES-DTU



Before TIMES-DTU

- Detailed calculations of potentials and costs were done for 360 building types
- Different levels for five different elements (walls, floors, ..) were considered
- Least expensive level was chosen for each element

Inputs to TIMES-DTU

- Curves of potentials and costs have been grouped by:
 - region (DKE and DKW)
 - building type (Detached and Mulstistorey)
 - construction year (built before and after 1972)
 - position relative to existing district heating areas (Central, Decentral, Individual)
- Curves of potentials and costs have been approximated with three step-curves

Heat savings in TIMES-DTU – potentials and costs

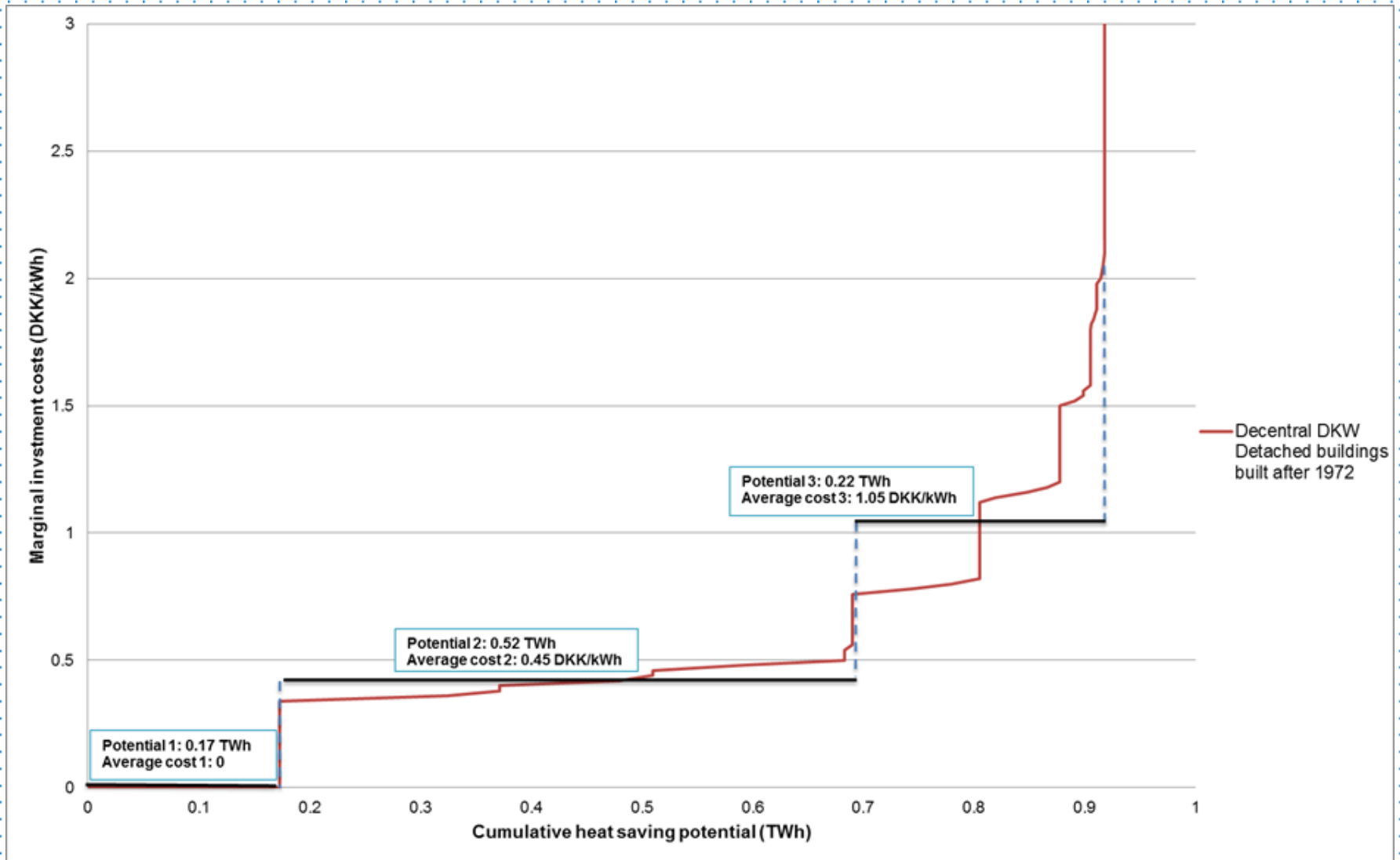

Heat savings in TIMES-DTU



- Heat savings deliver "heating services" according to heat degree days without DHW
- Heat savings are delivering "heating services" without any operation costs
- Different "steps" of heat savings have different lifetimes ranging from 30 to 40 years
- Maximal implementation rate is 10% out of total heat savings potential per time period

District heating in TIMES-DTU

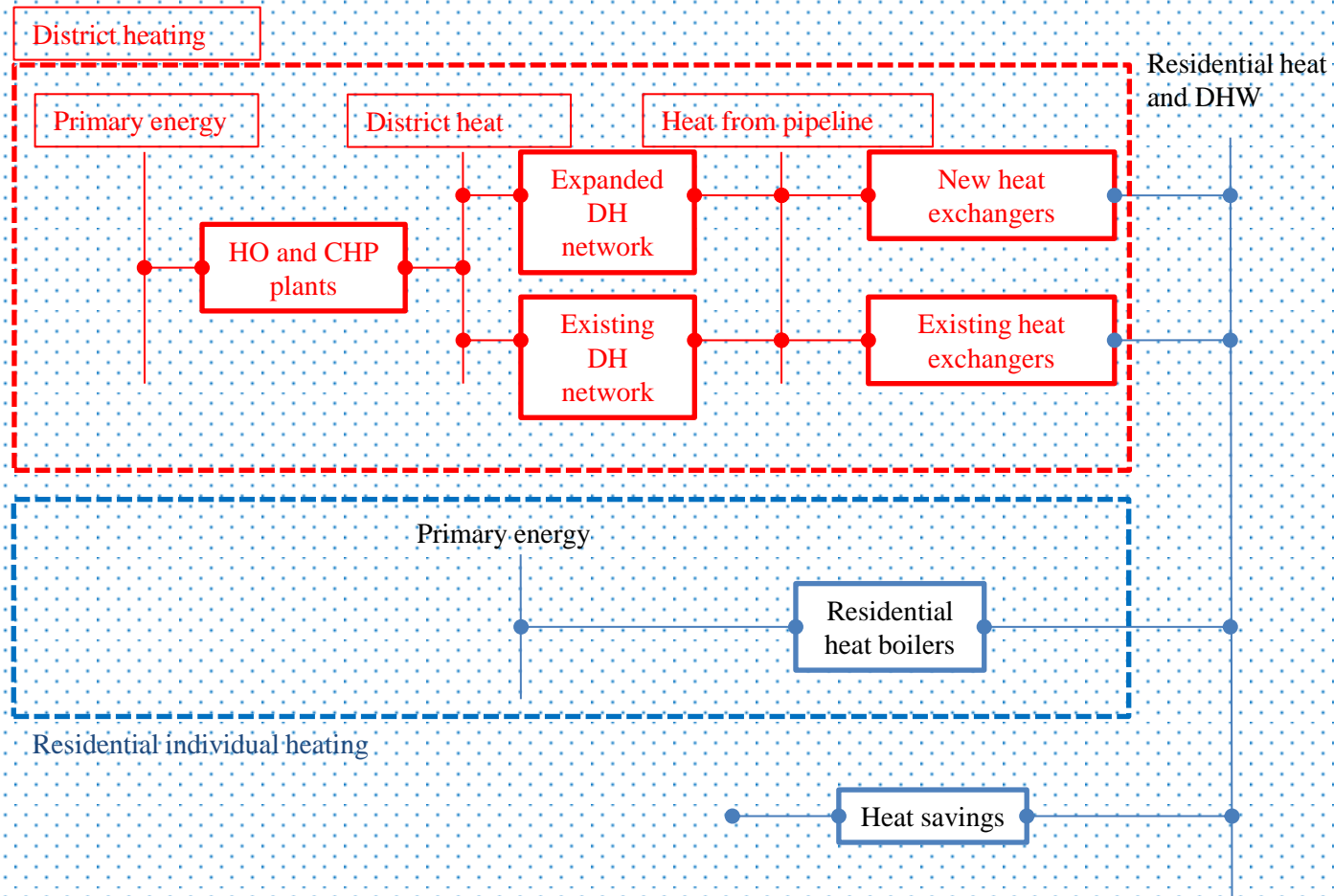

District heating in TIMES-DTU

- Two geographical regions: DKE and DKW
- Two types of district heating networks: Central and Decentral

District heating in TIMES-DTU – Central and Decentral areas

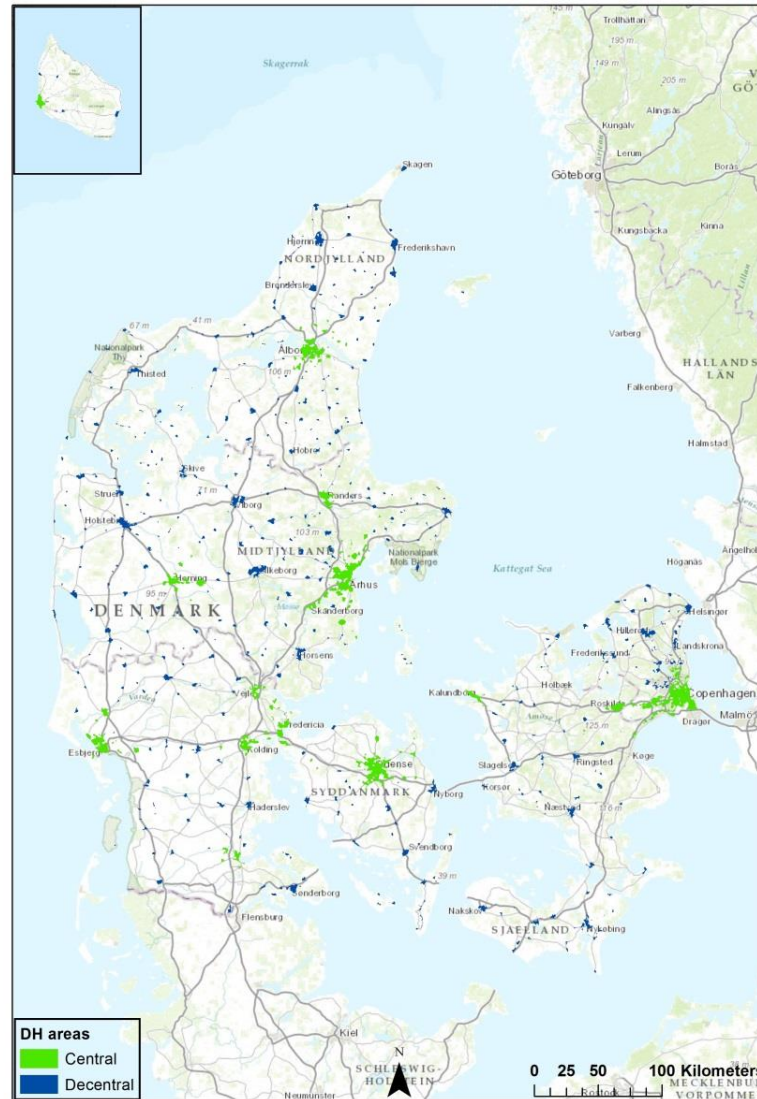

District heating in TIMES-DTU

- Two geographical regions: DKE and DKW
- Two types of district heating networks: Central and Decentral
- Two types of district heating areas: DH and Next-to-DH areas

District heating in TIMES-DTU – DH and Next-to-DH areas

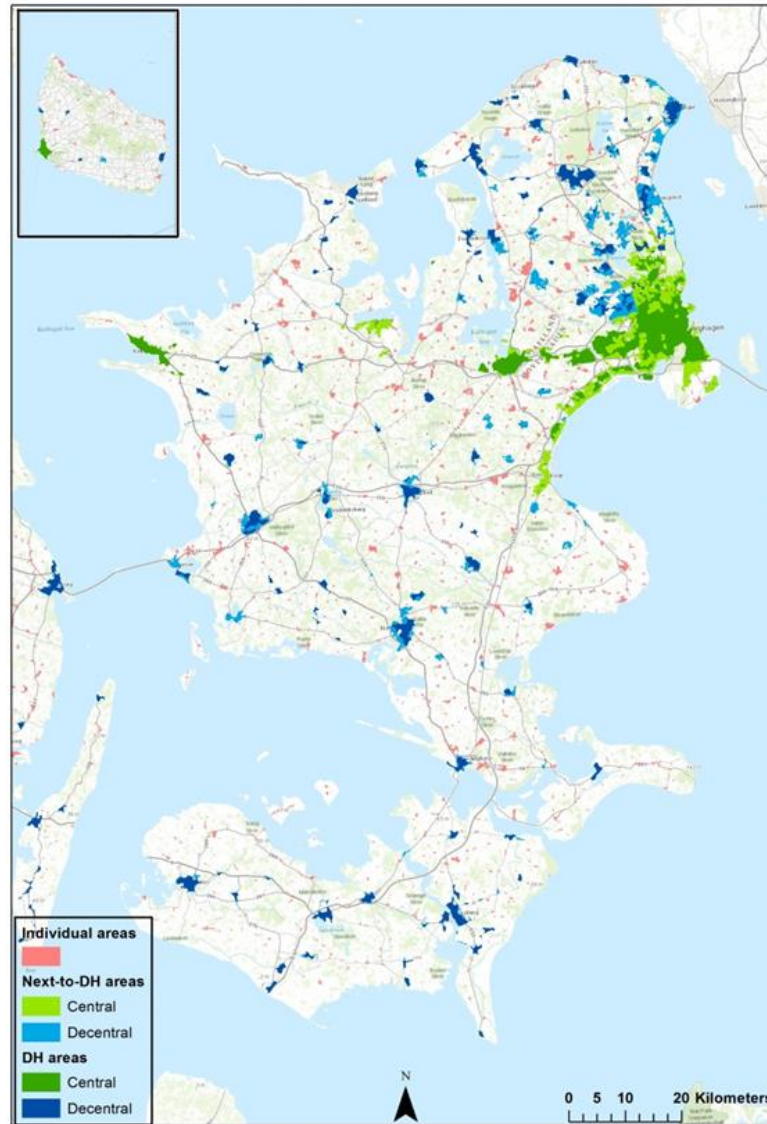

District heating in TIMES-DTU

- Two geographical regions: DKE and DKW
- Two types of district heating networks: Central and Decentral
- Two types of district heating areas: DH and Next-to-DH areas
- Two types of expansion of DH – within existing DH areas and to Next-to-DH areas
- Potentials and costs of expanding DH networks have been approximated with two-step curves

District heating in TIMES-DTU – expansion curves

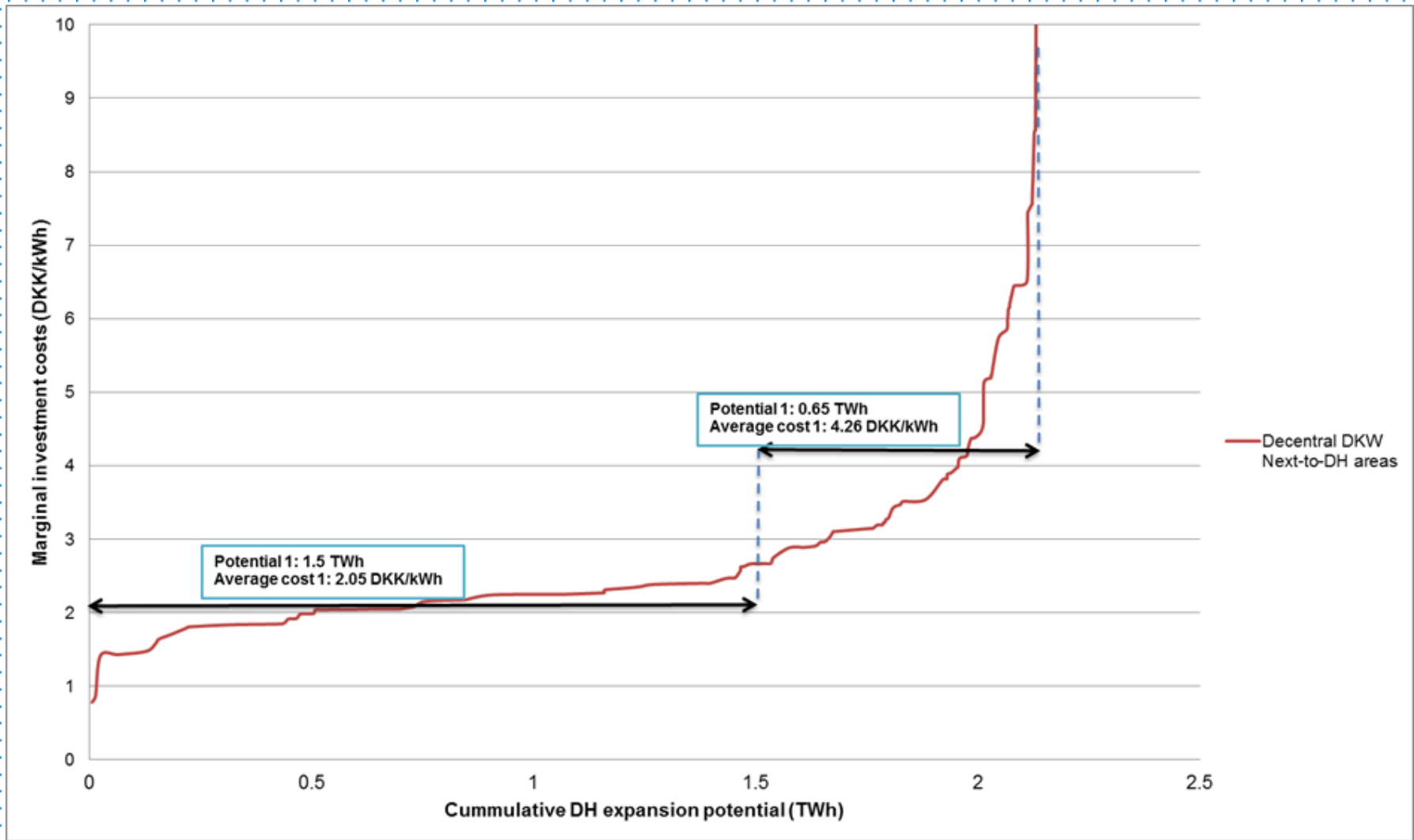

District heating in TIMES-DTU

- Two geographical regions: DKE and DKW
- Two types of district heating networks: Central and Decentral
- Two types of district heating areas: DH and Next-to-DH areas
- Two types of expansion of DH – within existing DH areas and to Next-to-DH areas
- Potentials and costs of expanding DH networks have been approximated with two-step curves
- Lifetimes and invest. costs are different for transmission and distribution pipes and connecting pipes and heat exchangers

Results from TIMES-DTU



Three basic scenarios:

- Base – base scenario without any policy measures being implemented.
- WLP (Wind Low Production) – starting from 2020 at least 50 % of electricity needs to be produced from wind power.
- WLP-NFE (Wind Low Production – Non Fossil Energy) – in addition to WLP scenario, no fossil fuels will be used for production of electricity and heat after 2035.

Results from TIMES-DTU – Heat supply

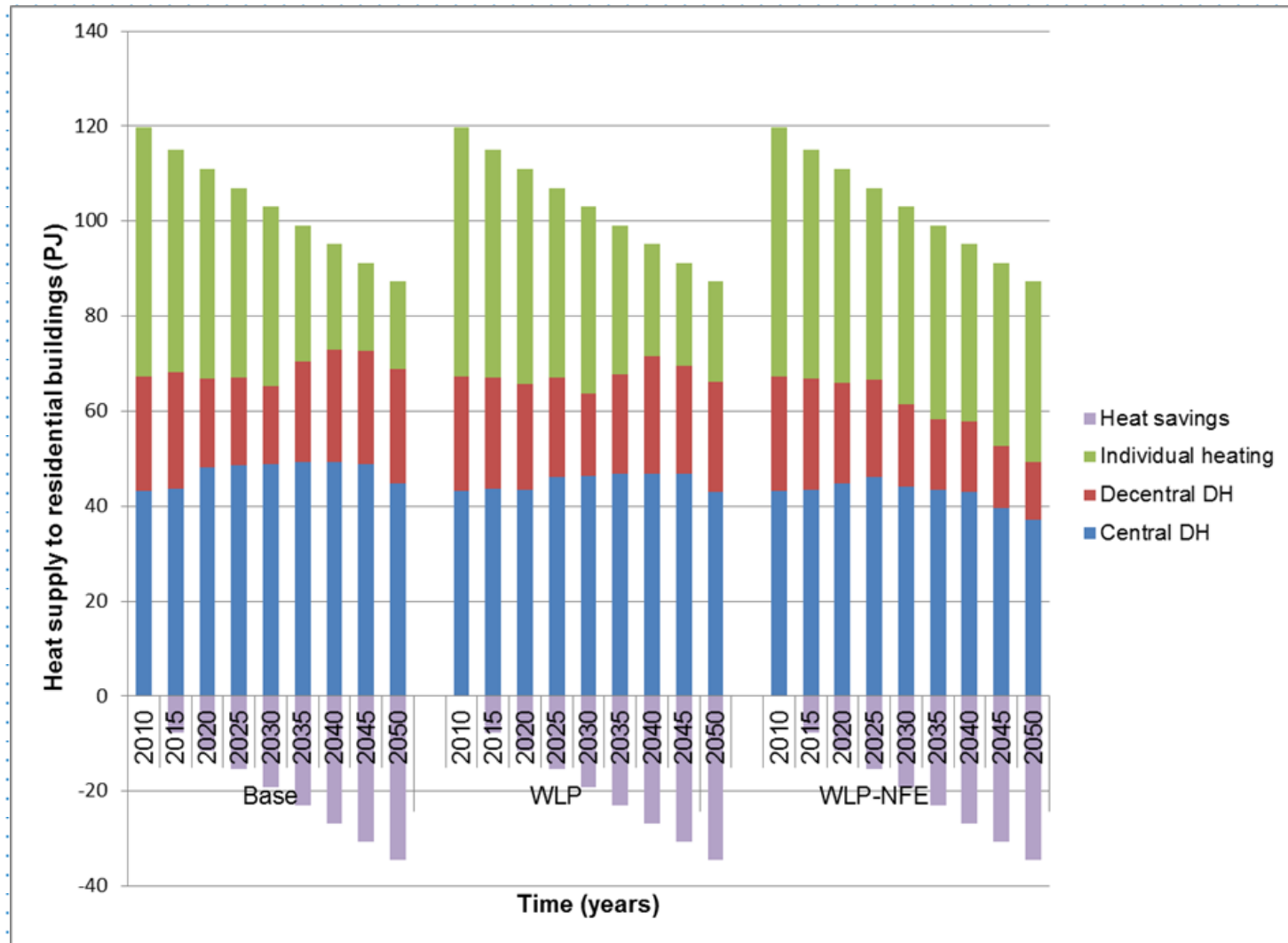

Results from TIMES-DTU – Central DH production

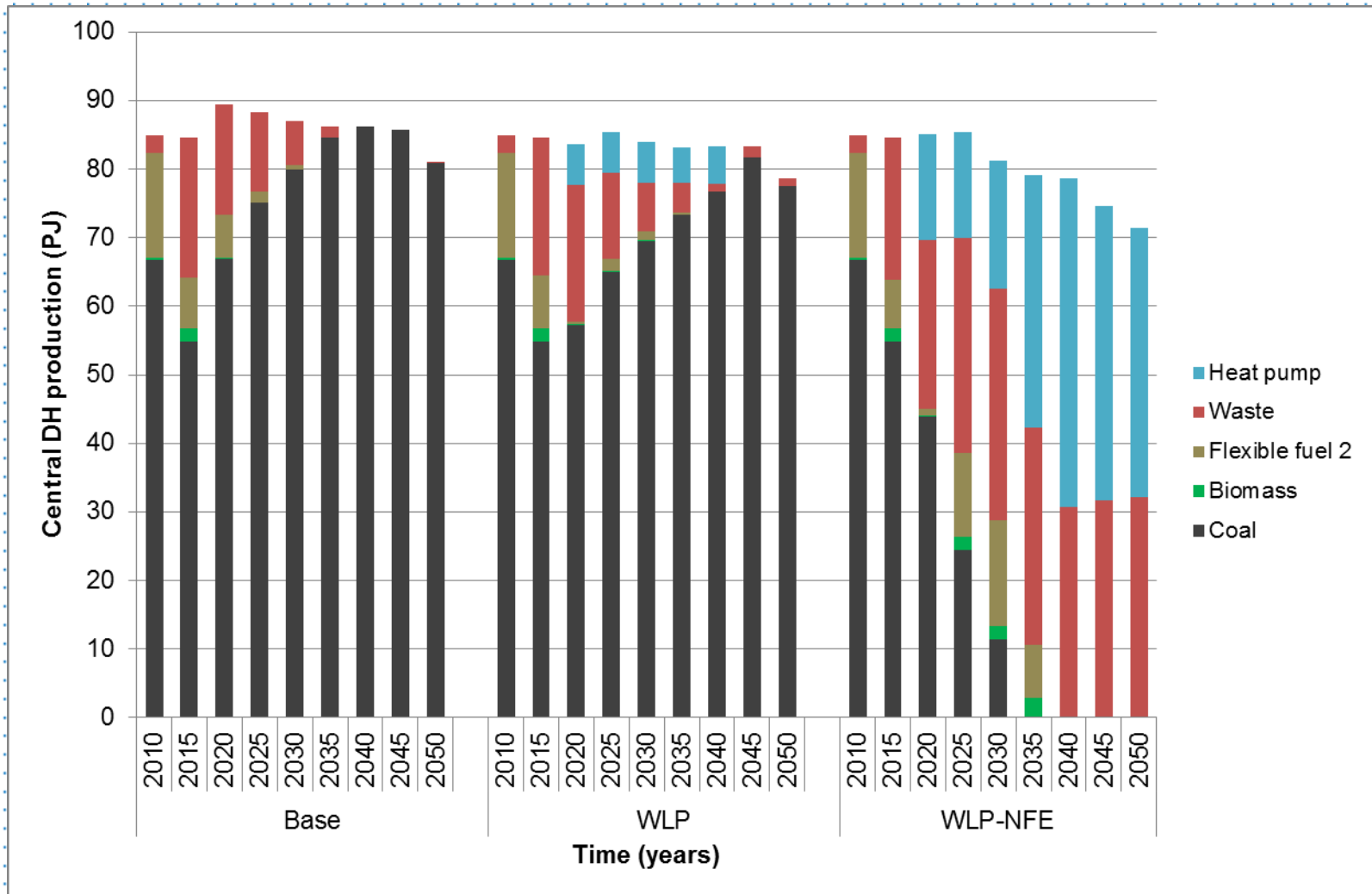

Results from TIMES-DTU – Decentral DH production

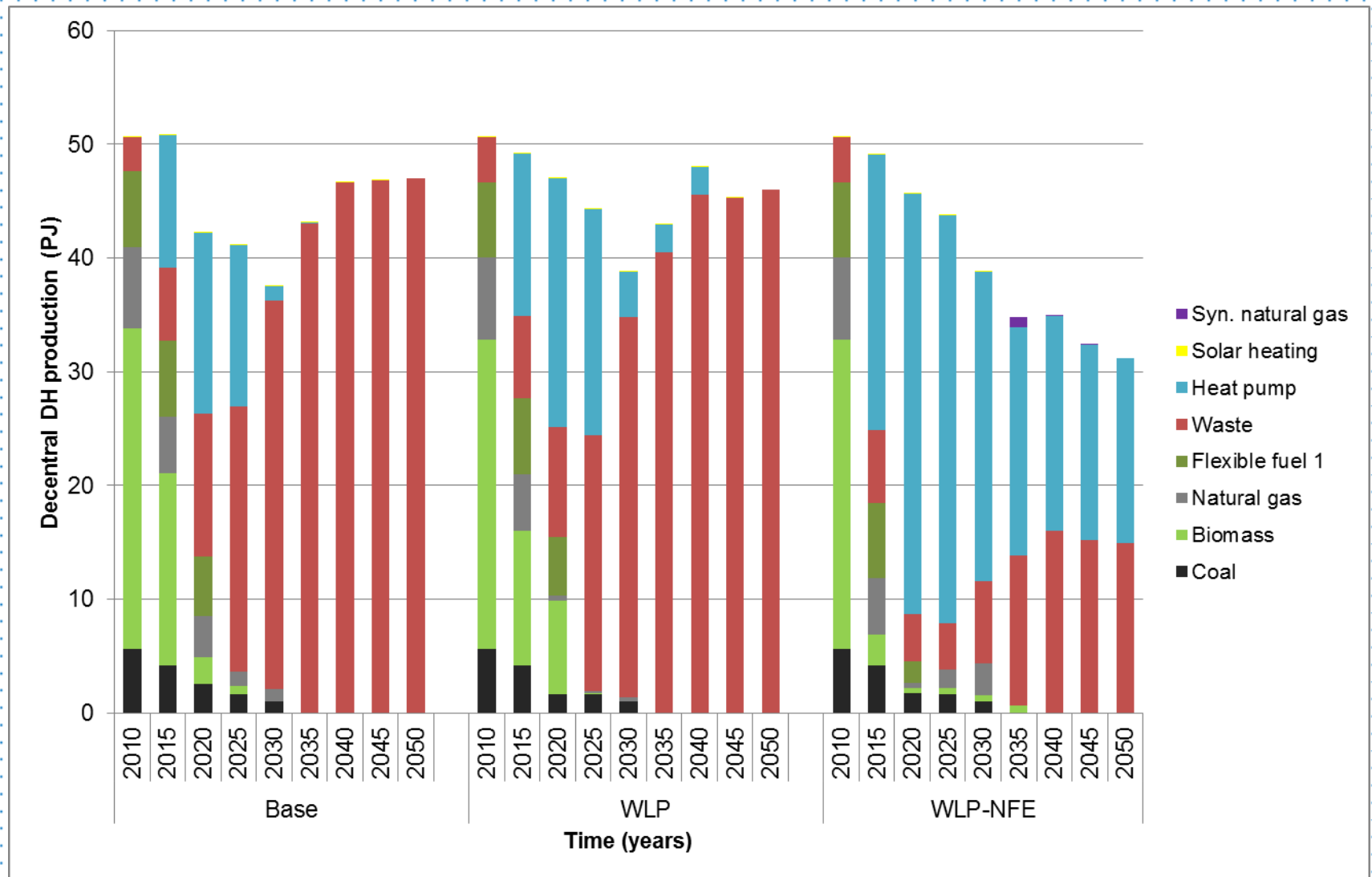

Results from TIMES-DTU – Heat savings divided by building type

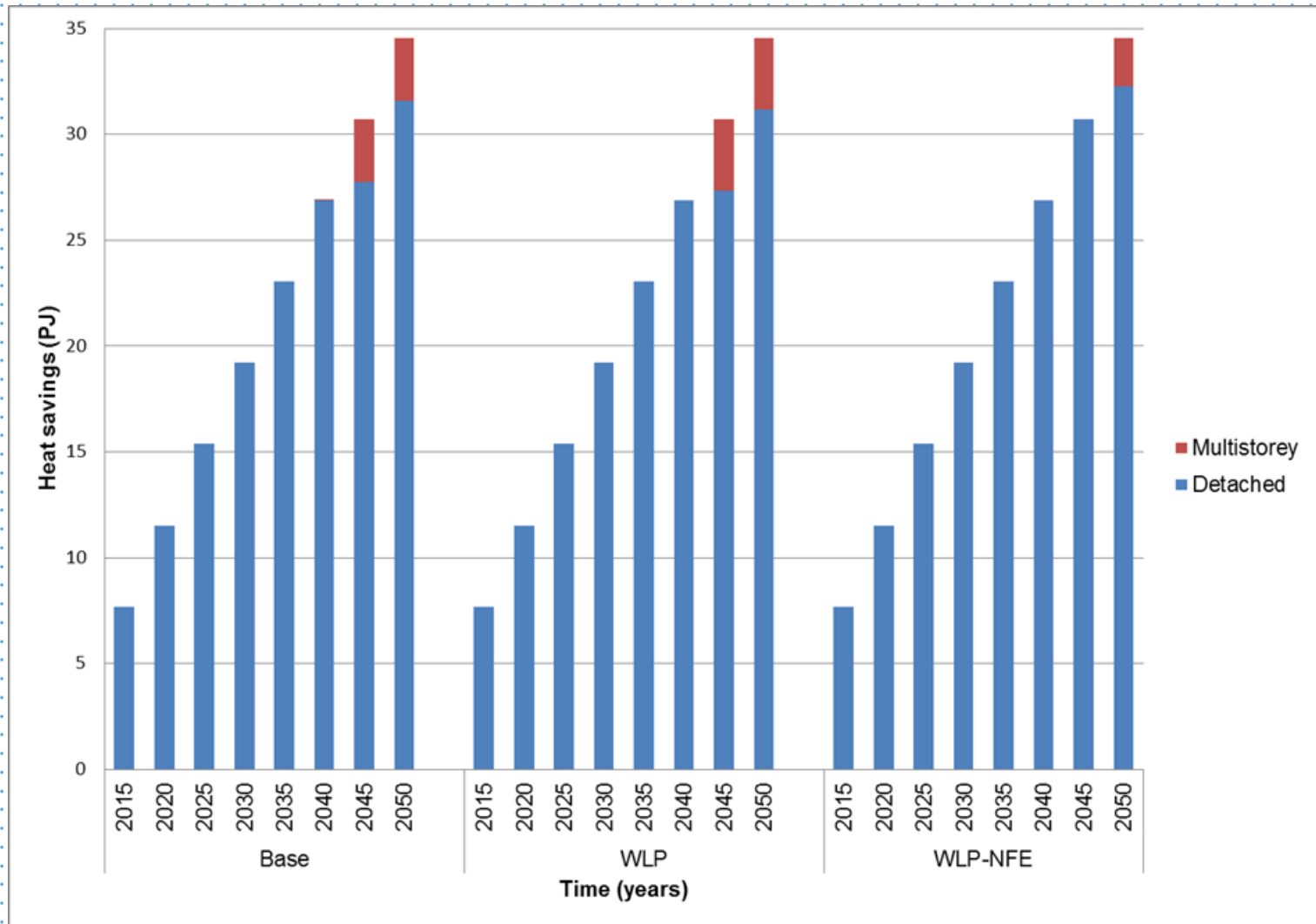

Results from TIMES-DTU – heat savings divided by geographical area

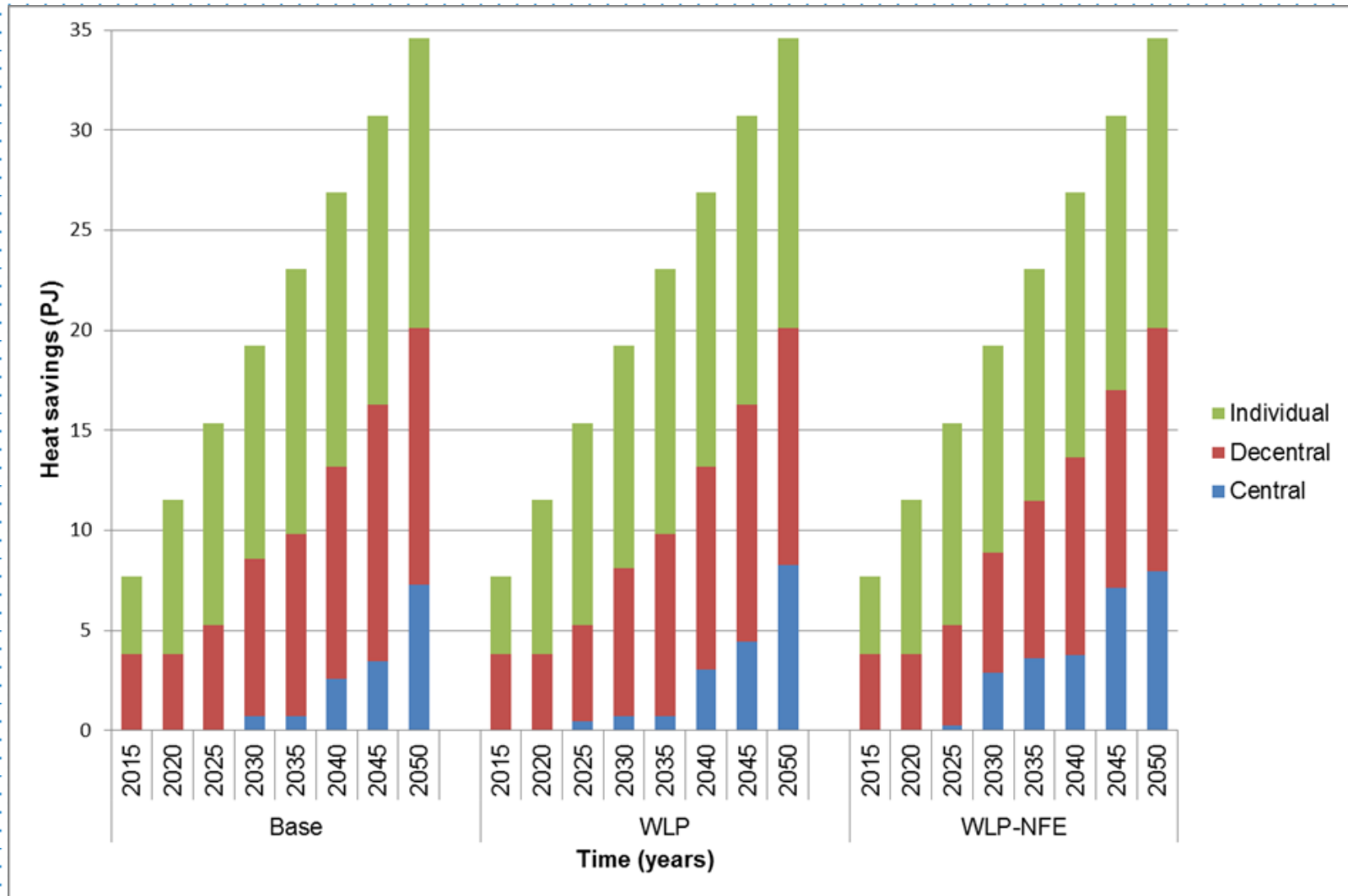

Thank you for your attention

Questions and answers

Contact:

Stefan Petrovic, e-mail: stpet@dtu.dk

mobile: 2465 5732